

**国内功率 IDM 龙头，国产替代稳步前行**



	2018	2019	2020E	2021E	2022E
	6,270.80	5,742.78	6,930.34	8,526.82	10,099.92
(%)	6.73%	-8.42%	20.68%	23.04%	18.45%
	429.44	400.76	967.38	1,339.22	1,566.08
(%)	511.02%	-6.68%	141.39%	38.44%	16.94%
(%)	25.20%	22.84%	28.58%	29.50%	28.84%
ROE(%)	10.76%	8.37%	12.06%	9.81%	9.01%
EPS	0.52	0.48	0.80	0.99	1.16
P/E	124.97	218.05	81.30	65.25	55.80
P/S	13.94	15.22	12.61	10.25	8.65



	.....	6
+	<b>IDM</b> .....	7
2	.....	
3	.....	
4	.....	
	.....	12
1	.....	
2	.....	
3	.....	
4	.....	
	.....	21
1	.....	
2	.....	
3	.....	
4	.....	
5	.....	
	.....	31
1	.....	
2	.....	31540





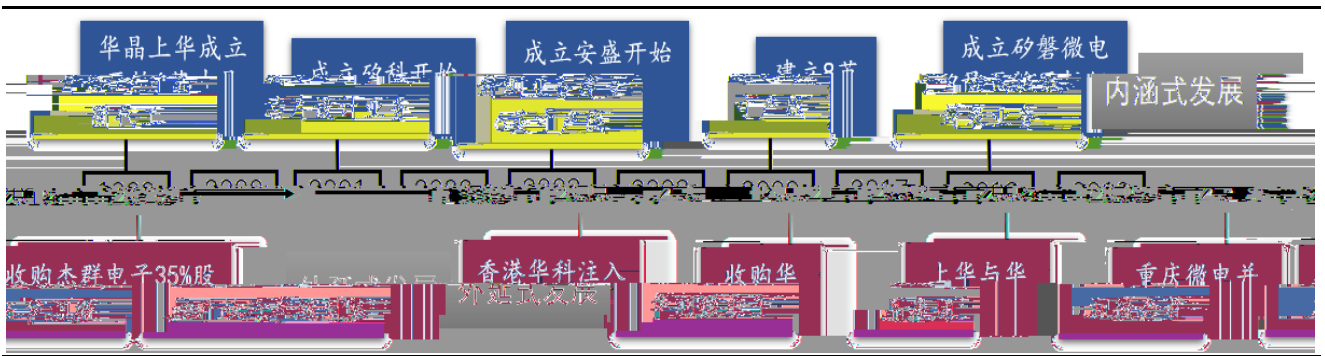

1

					MOSFET	IGBT	SBD	FRD	
	IC	AC-DC	LED	IC	BMSIC		IC	IC	IC
							IC		
					MEMS				
					MCU		MCU	MCU	

2

			2016	2018		43.97	
62.71			2017		2019		
		57.43	<b>2020</b>		<b>48.89</b>		<b>18.32%</b>
					2017		
4.01	2018		4.29		2019		
	<b>2020</b>						
<b>6.87</b>						<b>2019</b>	<b>1.5</b>
				2016	2020		<b>2016</b> <b>14.49%</b>
	<b>2020</b>		<b>28.12%</b>				
2017		2018		6.84%	2019		6.98% <b>2020</b>
		<b>14.05%</b>					

2016 23.61%  
 2019 14.90%

 2019 1H 26.94%  
 2020

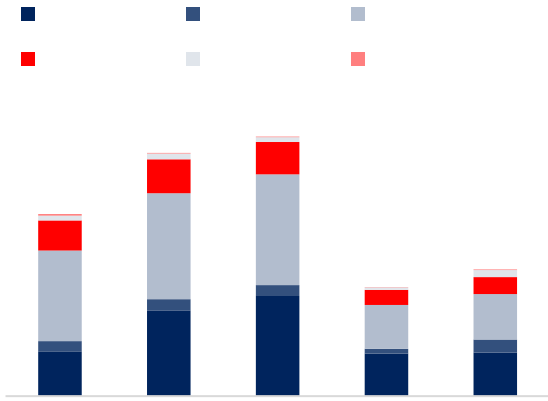
 2016 7.85%  
 28.12%

Wind

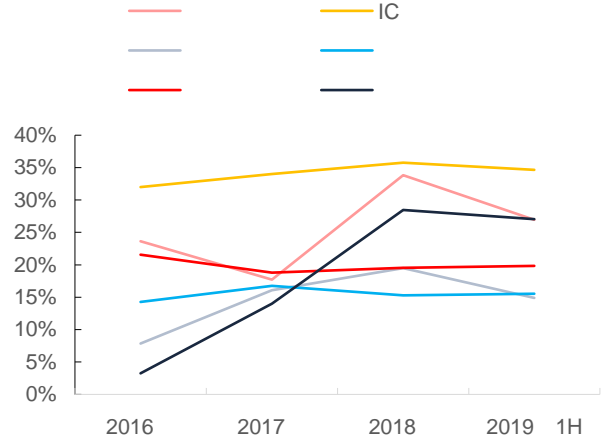

Wind

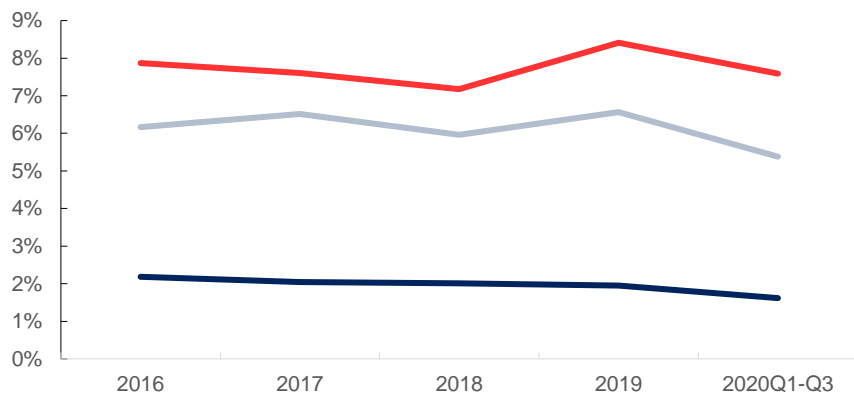

wind



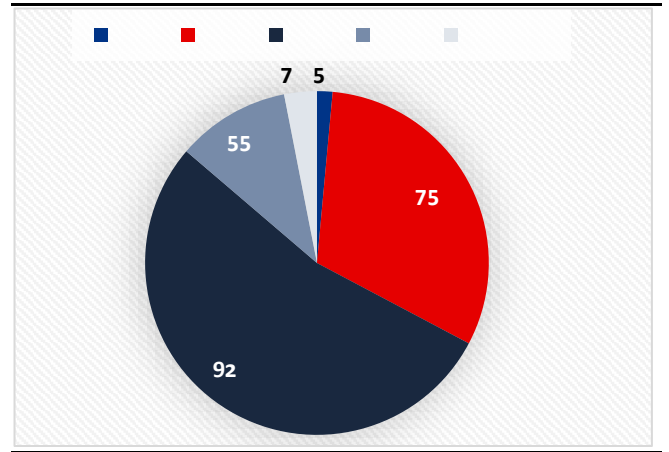
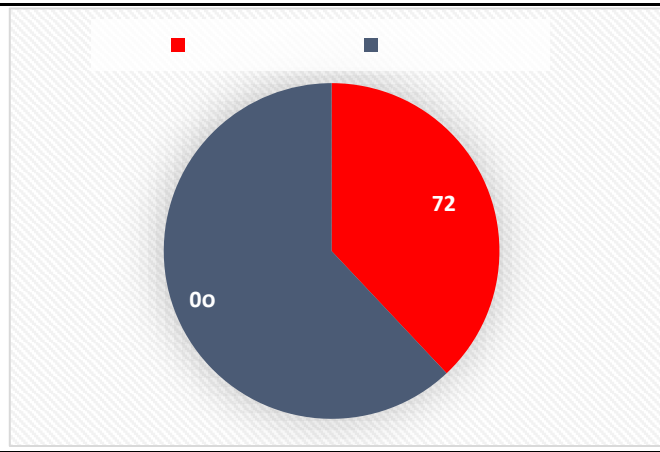

1

2019

WSTS

2019

2019

3303.5

656.7

541.5

239.6

MOSFET IGBT

132.3

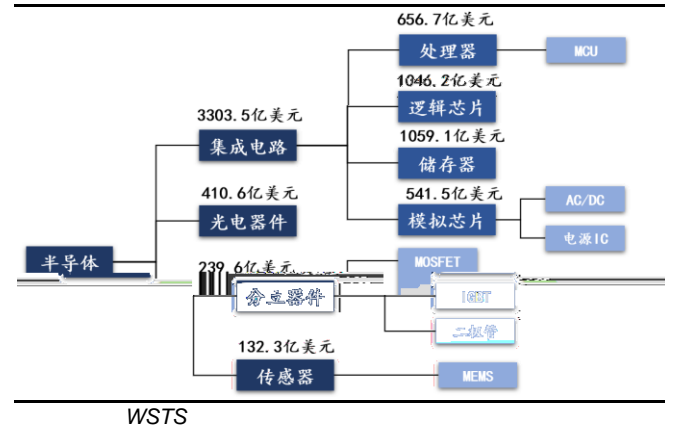
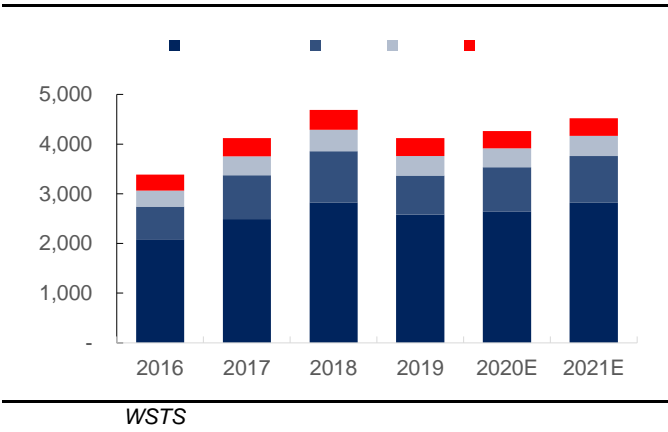

PC

BCG Analysis

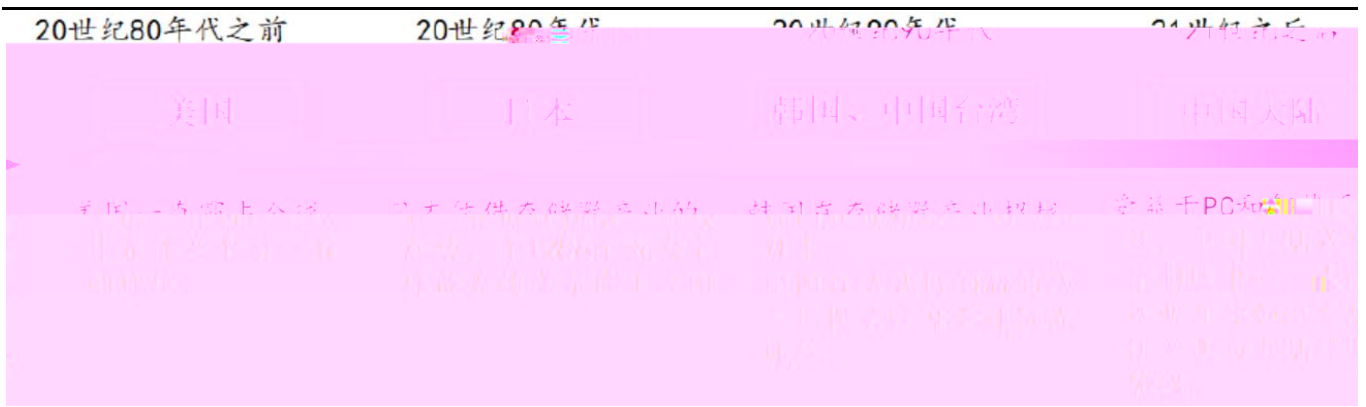
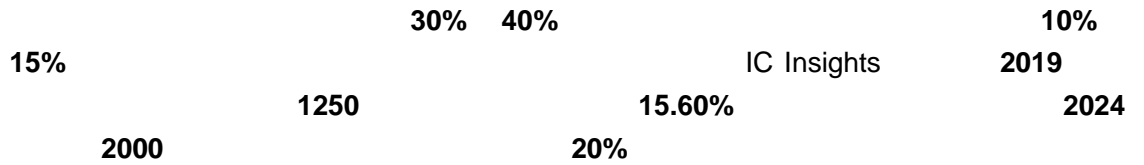

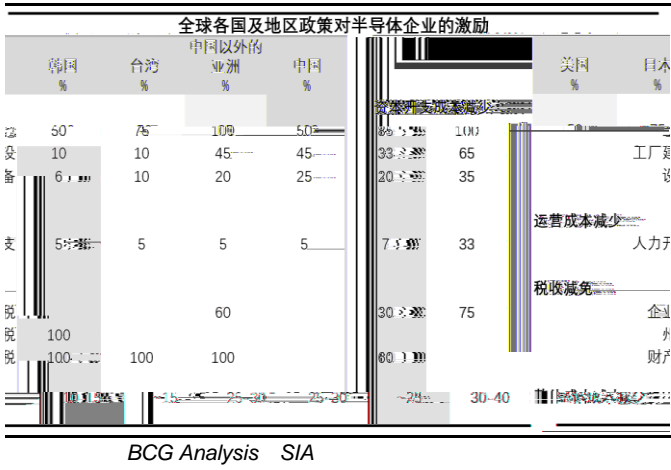

SIA

60%

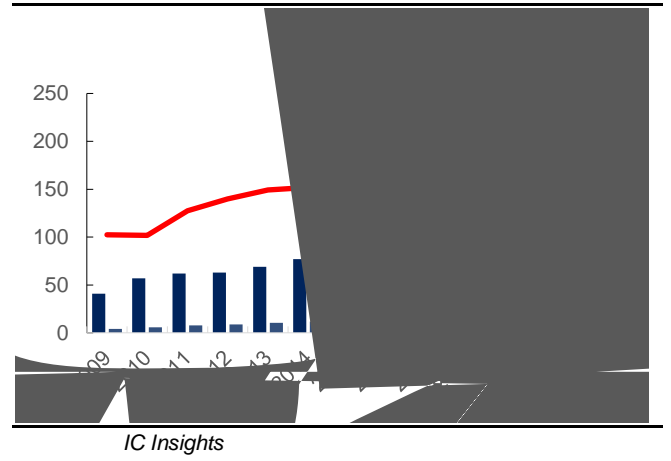

5%

47%

SIA

SIA



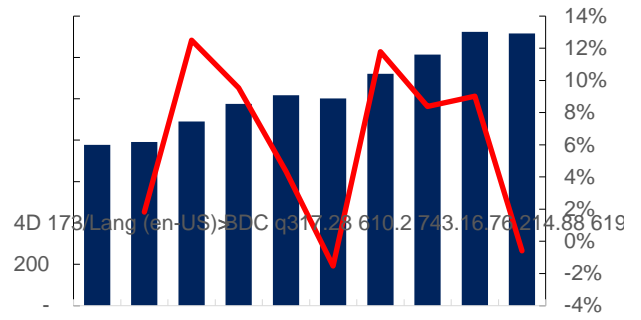
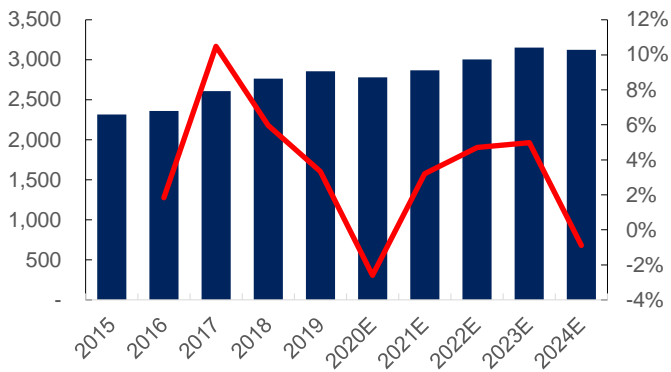

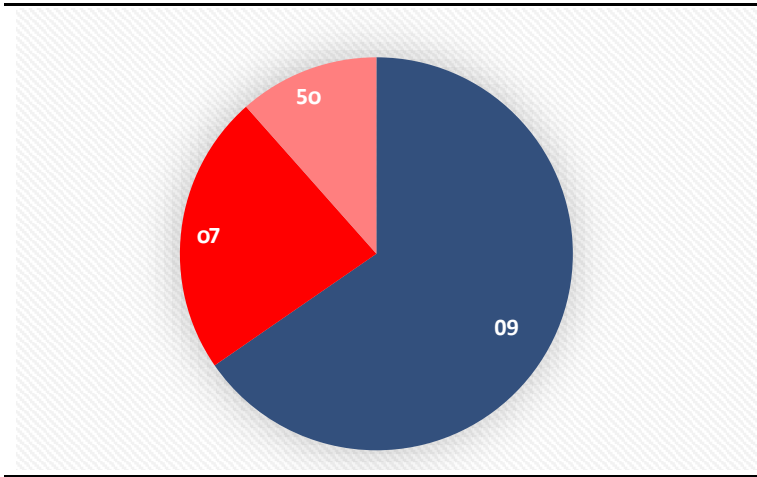

---

*iPhone12*

---

*Mate 40*

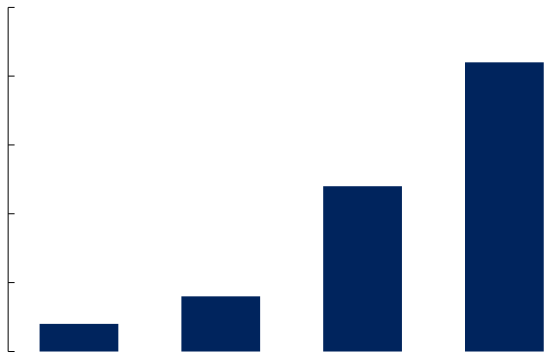
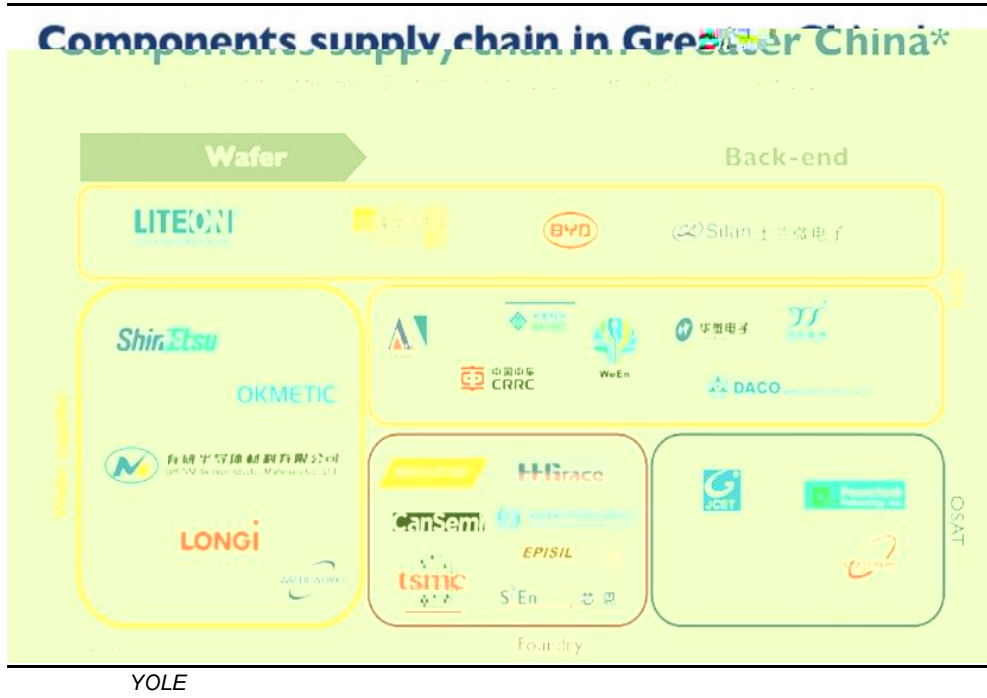

YOLE

2

eV

Ge	0.66
Si	1.12
GaAs	1.42
SiC	3.05
GaN	3.44
AlN	6.2
C	5.47
AnO	3.37

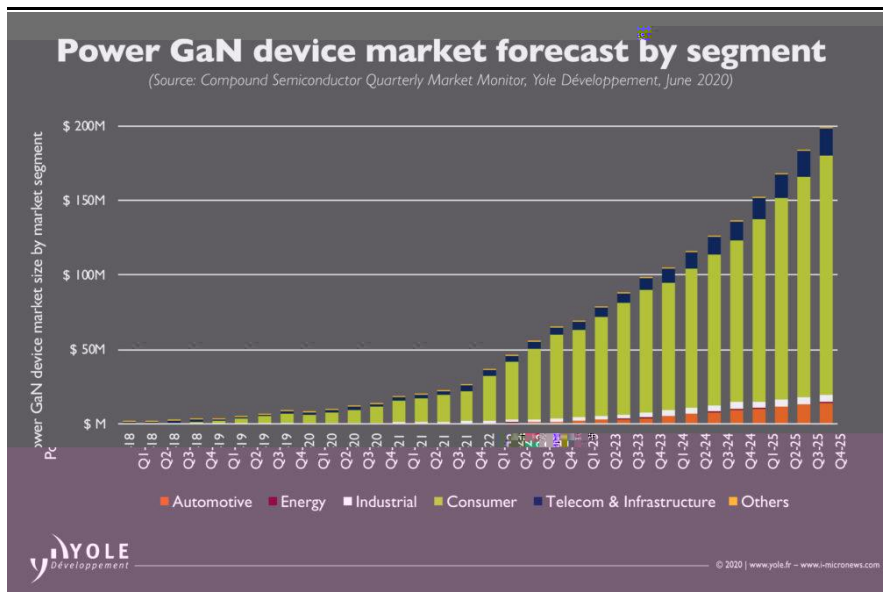
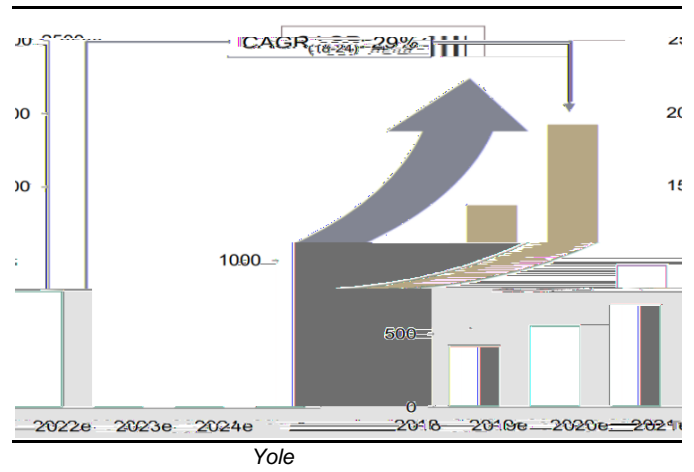
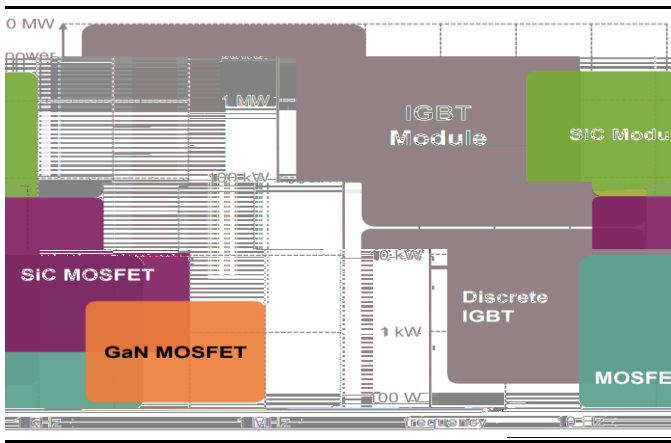

YOLE



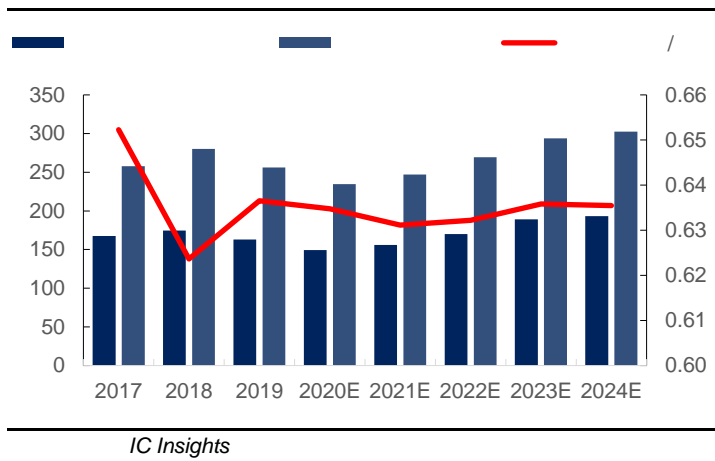
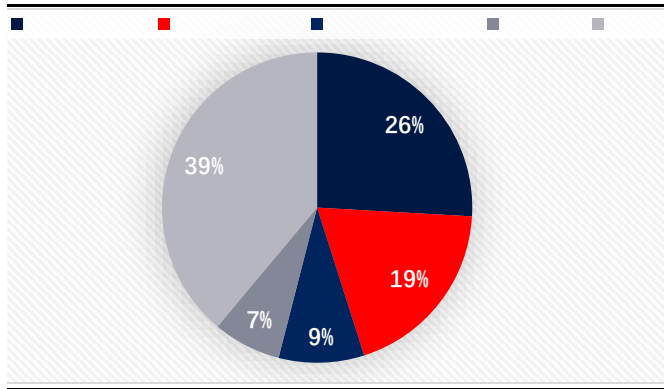

1

IDM

IDM

8  
IDM

IDM

2017

2017

IDM

2017

3.62

2018

2.41

2019

2.45

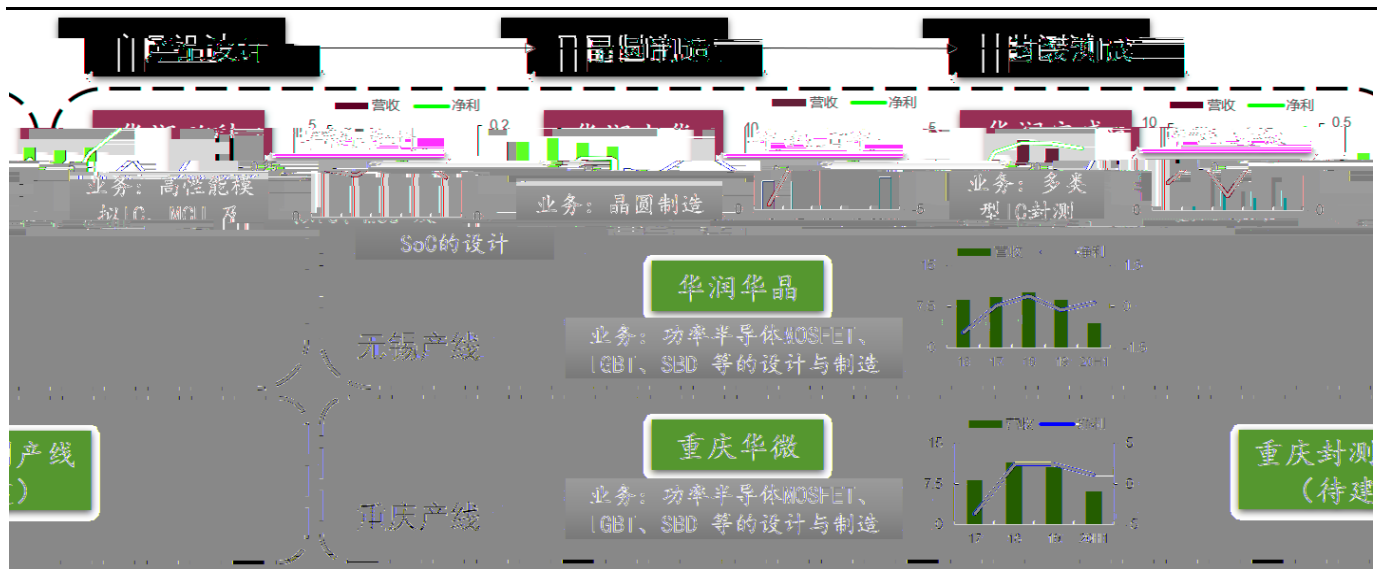

2017

IDM

2018

IDM

IDM

IDM

IDM

IDM

3 2018

1	509	1	Samsung Electronics	759	IDM
2	248	2	Intel	659	IDM
3	239	3	SK hynix SK	364	IDM
4	225	4	Micron Technology	306	IDM

5		111	5	Broadcom	165		
6	( )	107	6	Qualcomm	154		
7		92	7	Texas Instruments	148	IDM	
8		66	8	Western Digital	93	IDM	
9		65	9	ST Microelectronics	93	IDM	
10		63	IDM	10	NXP	90	IDM

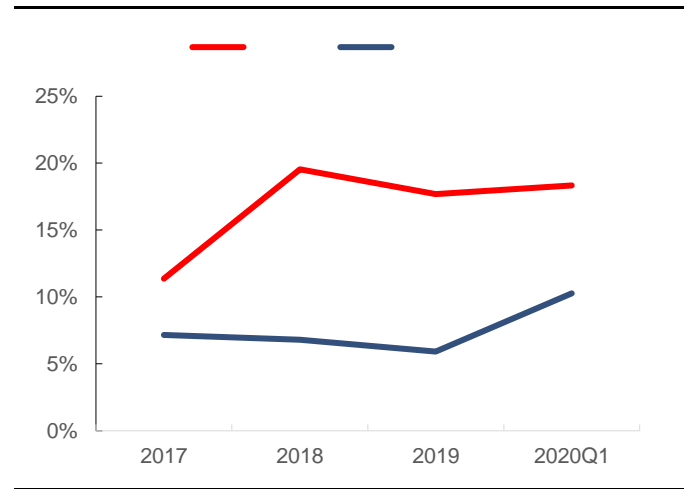
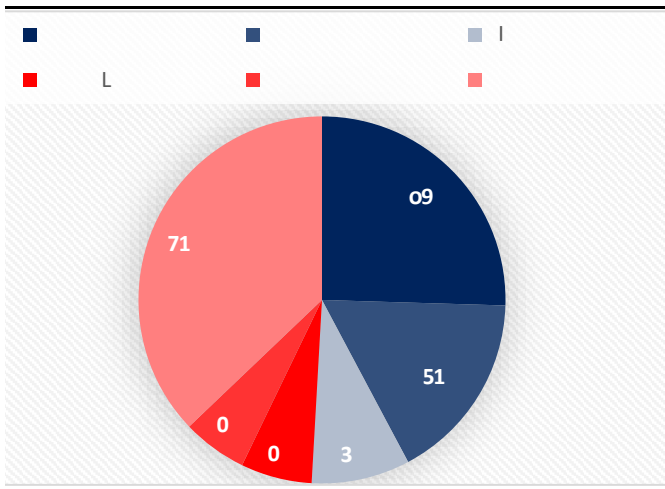

2

4 2018

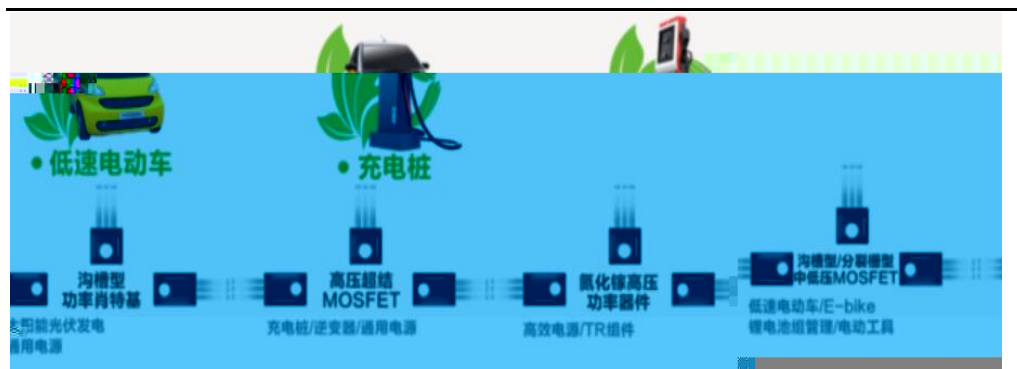
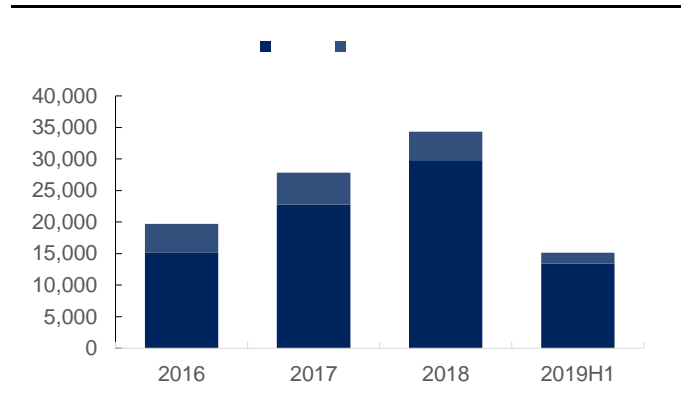
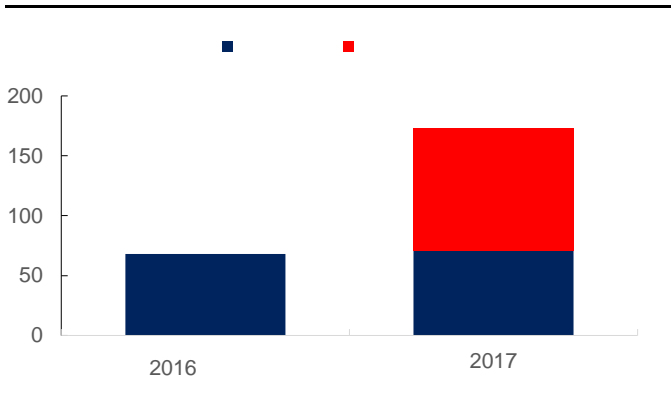
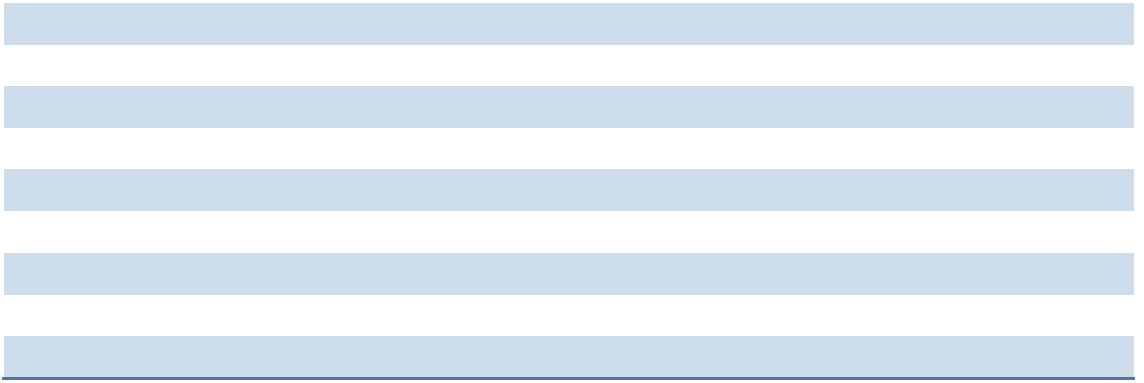

5

ISO/TS16949	ISO9001				
ISO14001	GP	1,100	500	IC	
ROSH					

IATF16949	ISO14001	OHSAS18000					
	ERP	MES	SPC	EAP	RMS		
						2020	3 31
							58

ISO9001							
						IPM	IDM

ISO/TS16949	ISO9001							
ISO14001	GP	ROSH			MOSFET	MOSFET	IGBT	IGBT
ECO				PIM		2019		
				416				

ISO9001	ISO14001			SiCJBS	MOSFET		
					Clip		WB
				7			
							2019

4

ISO/TS-16949	ISO-9001	ISO-14001	OHSAS-
18001			

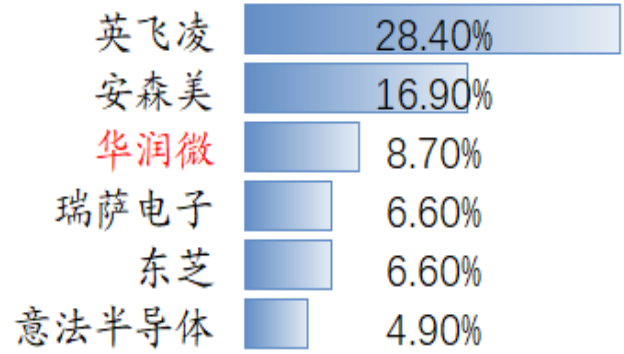

## 6 MOSFET

30V-900V	40V-900V	-60V-150V	-100V-1500V
MOS			MOS
MOS			MOS
MOS	MOS	MOS	MOS
MOS	MOS	MOS	MOS
MOS		MOS	MOS
			P MOS

## 7 IC

AC-DC	AC-DC		
LED	IC	LED	
BMS IC			
IC		78 1117	100mA-1A
IC			100W
IC			
IC	AB	D	5mW-50W



3

8 2019

1	
2	
3	
4	SK
5	
6	
7	
8	
9	
10	



SGT MOSFET

		/			
BCD	BCD	1	1.0-0.18μm	2	
	SOI BCD	5V-700V 3		4	200-600V SOI
MEMS	MEMS	1	MEMS		2
	MEMS			3	
	MEMS			MEMS	
	IPM		IMS		IPM
	PQFN/PDFN	1	2		
		3	CopperClipBond		FC
		1		3	2
300um					

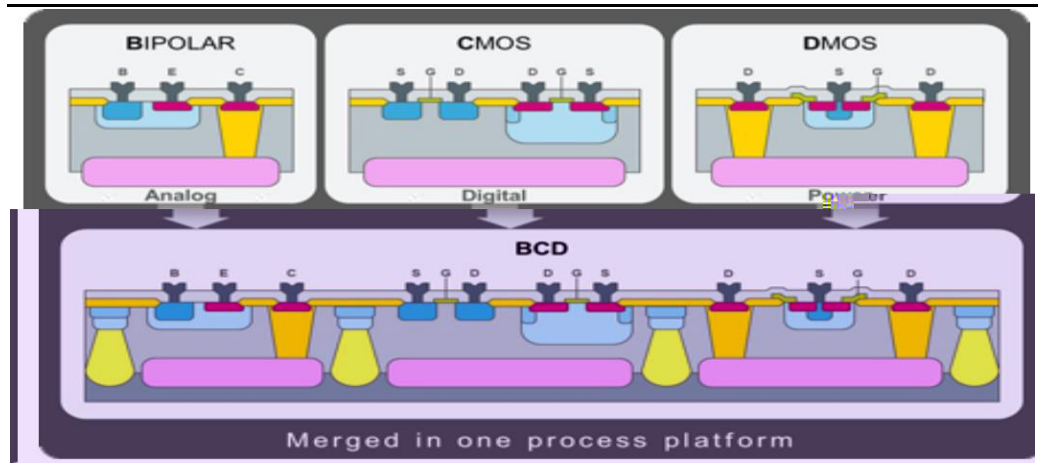

				MEMS	IPM	48
				MOS	IGBT/SBD/FRD	123
ASIC	MCU	SOC IC		MCU	ASIC	177
				BCD	MEMS analog CMOs	154
				QFP	QFN 3D IPM	54
						8
						28

IC	,	BMS	AC-DC	44
				5

**13**

2018	10	IGBT	iPOWER Semiconductor	5
2017	11			5
2016	10			3
2016	5			5
2015	10			5







